

Sensitivity Wavelength Range: 800nm~2600nm

The MTSM2601SMR1-100 from Marktech, a high sensitivity and high reliability product series, is ideally suited for Optical Communication devices. Custom packaging options for this die is also available.

FEATURES

- > High Speed Response
- > 3mm x 3mm Seam Welded Surface Mount Package
- > Active Area of 1.0mm Φ / High Sensitivity
- > Spectral Range 800nm - 2600nm
- > Hermetically Sealed

APPLICATIONS

- > High Speed Optical Communications
- > Industrial Controls
- > Gas/Water Analysis
- > LIDAR
- > Medical

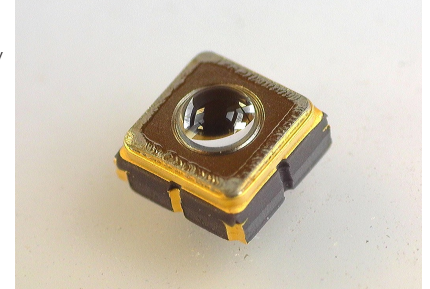

Absolute Maximum Ratings (Ta=25°C)

ITEMS	SYMBOL	RATINGS	UNIT
Active Area	Φ	1.0	mm
Operating Temperature Range	Topr	-40 to +85	°C
Storage Temperature Range	Tstg	-40 to +125	°C



Note: Also available on PCB - Starboard MTSM2601SMR1-100S (See Page 3)

Electrical & Optical Characteristics (Ta = 25°C)

ITEMS	SYMBOL	CONDITIONS	MIN	TYP	MAX	UNIT
Breakdown Voltage	VR	IR=100uA	--	--	1	V
Sensitivity Range	λ	VR=0V	800	--	2600	nm
Dark Current	ID	VR=0V	--	23	--	nA
Dark Current	ID	VR=1V	--	72	--	uA
Capacitance	C	VR=0V	--	750	--	pF
Capacitance	C	VR=1V	--	60	--	pF
Responsivity	R	$\lambda=2400\text{nm}$	--	1.24	--	A/W
Shunt Resistance	RS	VR=10mV	--	6	--	kOhm
Quantum Efficiency	QE	$\lambda=1840\text{nm}$	--	72	--	%
Light Current @ $\lambda=1300\text{nm}$	IL	If=10mA	--	65	--	μA
Light Current @ $\lambda=1300\text{nm}$	IL	If=20mA	--	150	--	μA

Package Dimensions

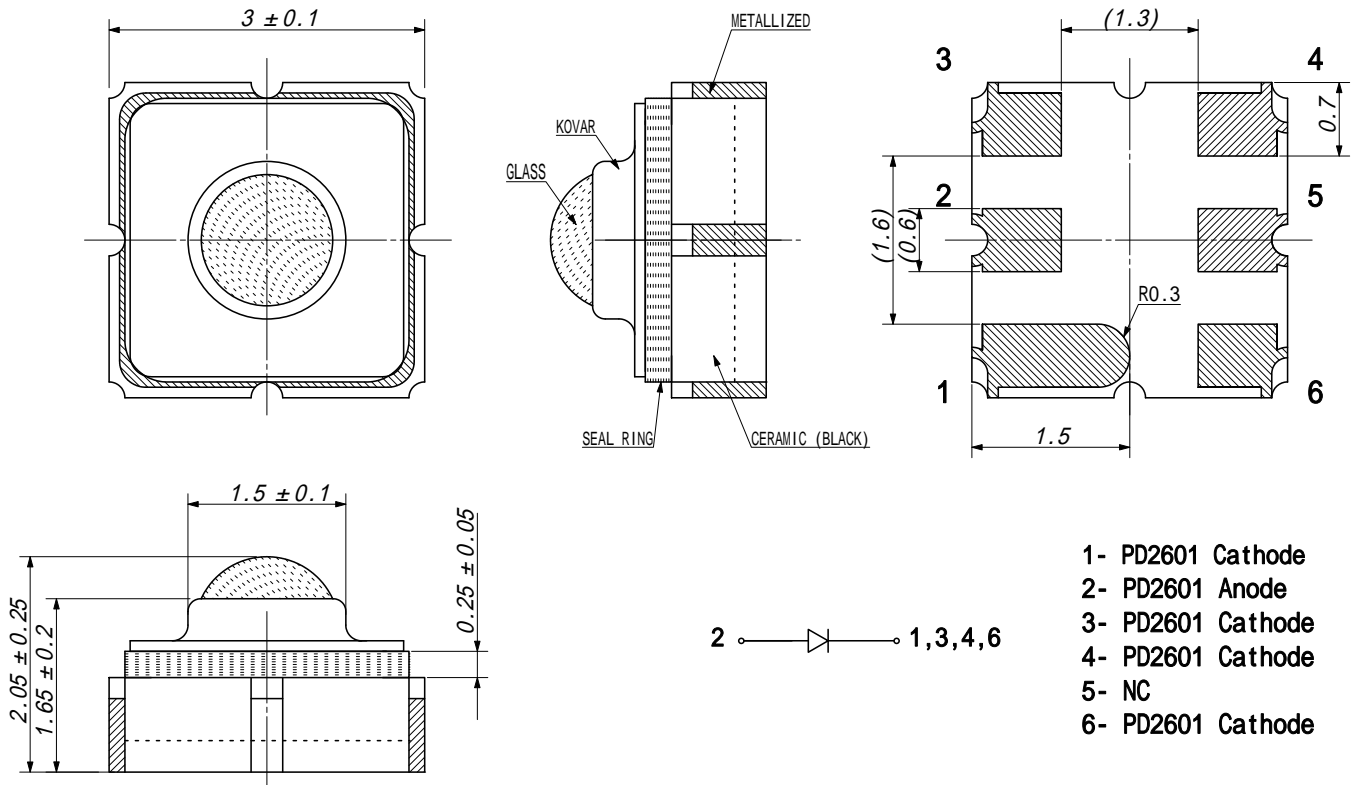

Recommended Soldering Pattern [mm]

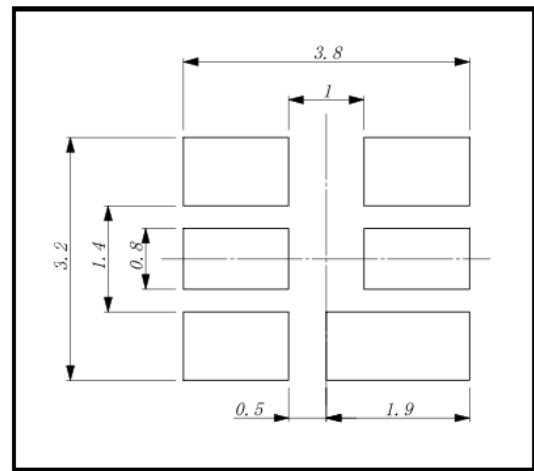

Reflow Soldering Temperature-Profile [Pb free Soldering] (Recommend condition)

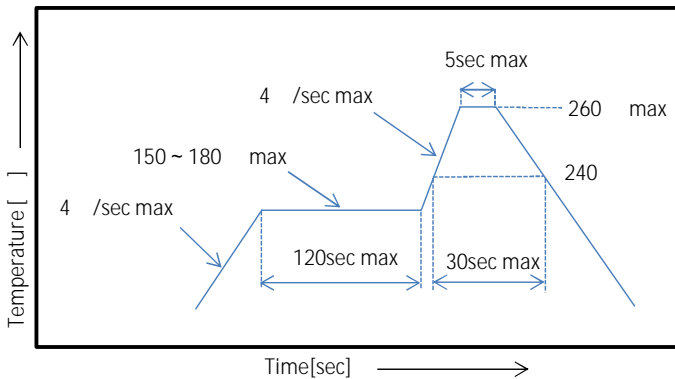

Unit: mm, Tolerance: ± 0.2

The information contained herein is subject to change without notice.

2024-09-03

Starboard Dimensions

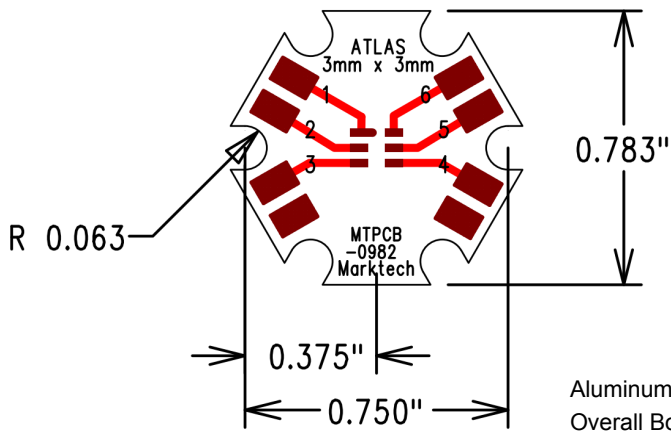

- Pin 1 Cathode
- Pin 2 Anode
- Pin 3 Cathode
- Pin 4 Cathode
- Pin 5 NC
- Pin 6 Cathode

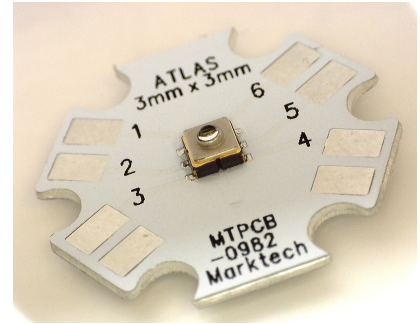

Aluminum Core Board 0.040" (1.02mm) Thickness
Overall Board Dimensions: +/- 0.010" (0.254mm)



We reserve the right to make changes to improve technical design and may do so without further notice. Parameters can vary in different applications. All operating parameters must be validated for each customer application by the customer.

The information contained herein is subject to change without notice.

2024-09-03

Spectral Responsivity

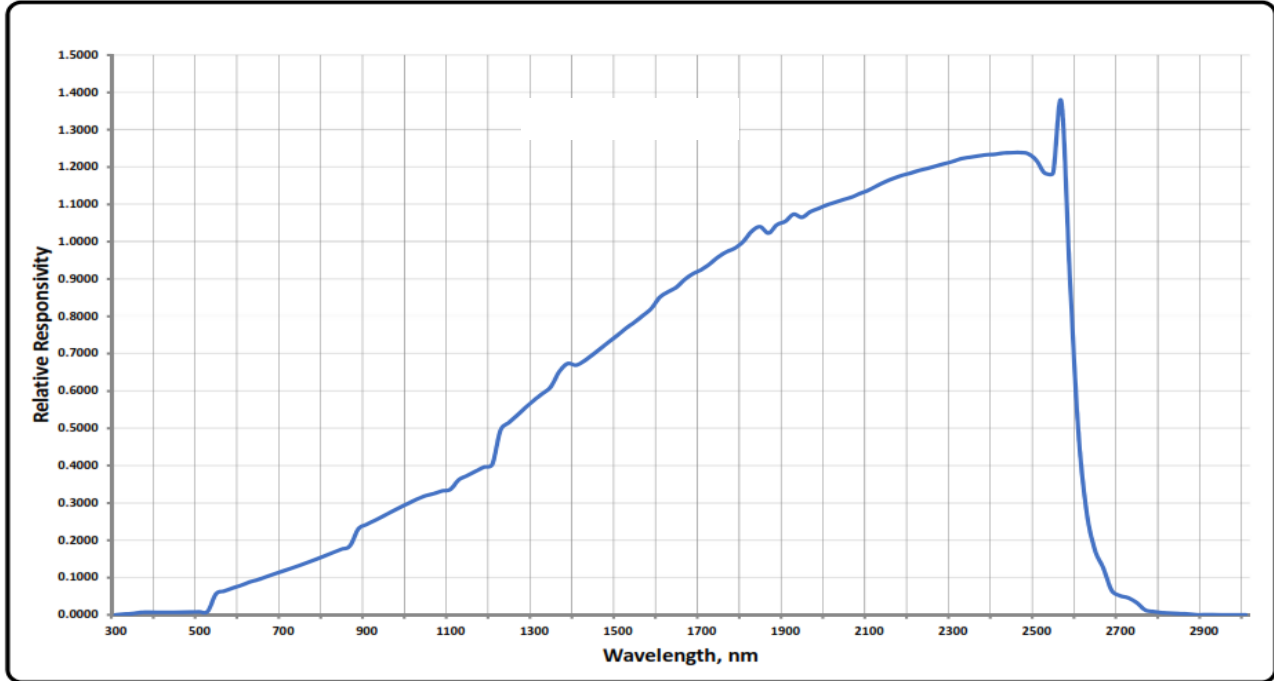

Quantum Efficiency

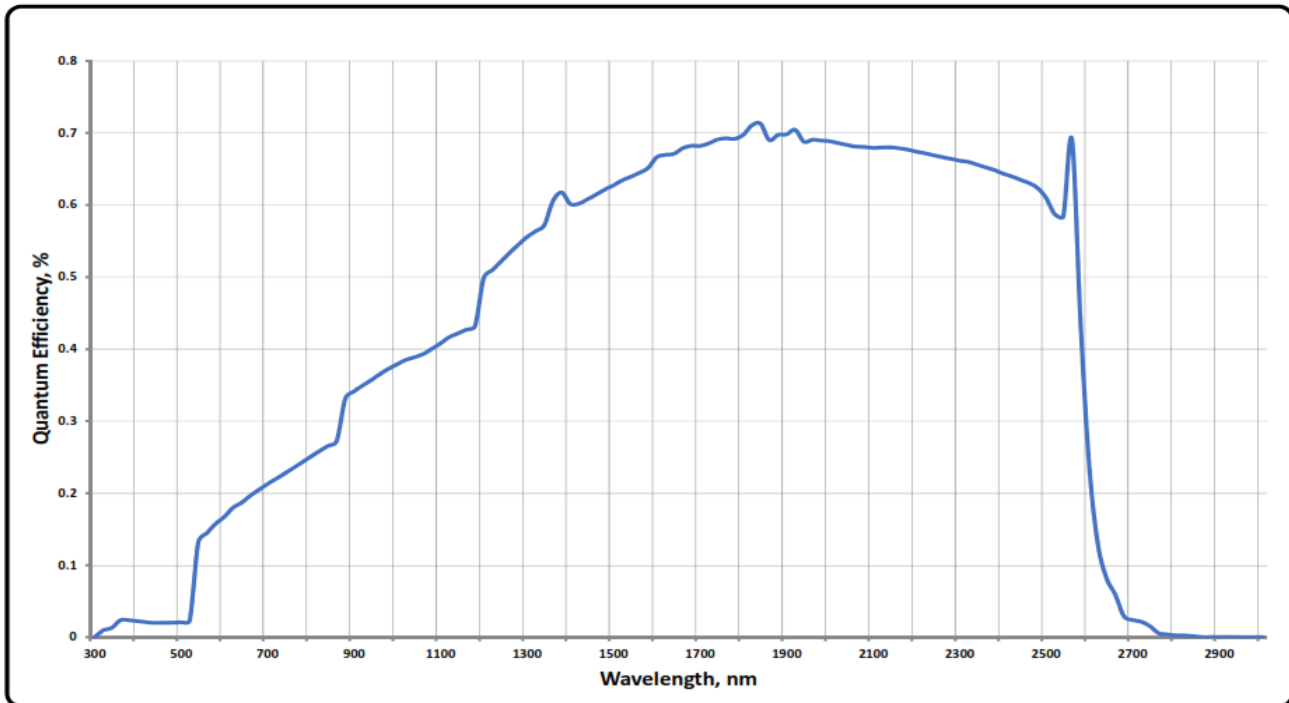

The information contained herein is subject to change without notice.

2024-09-03

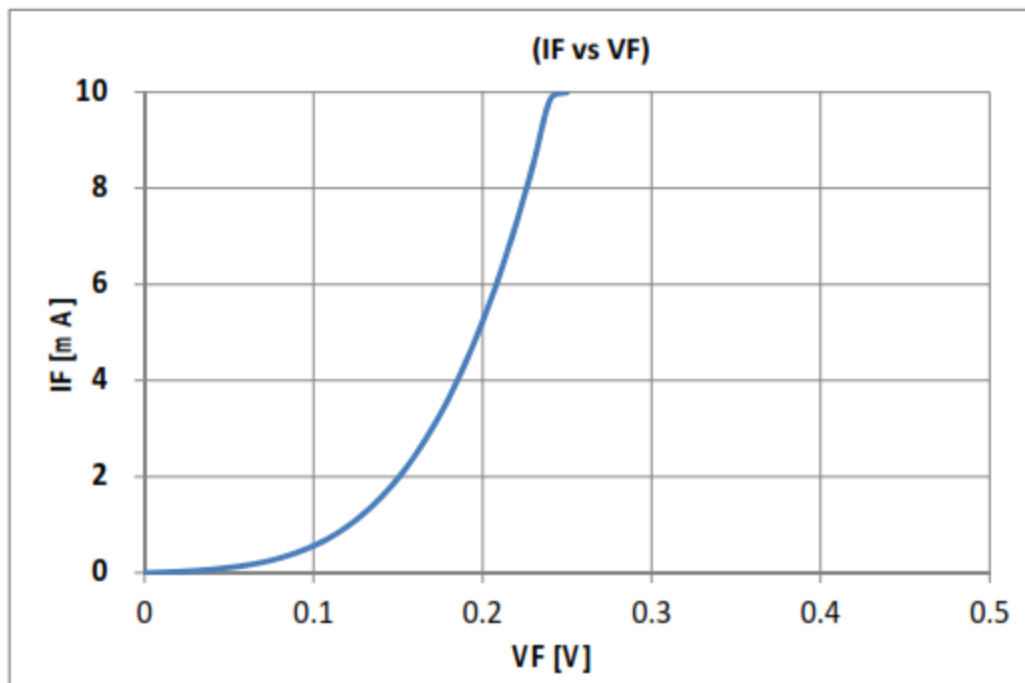
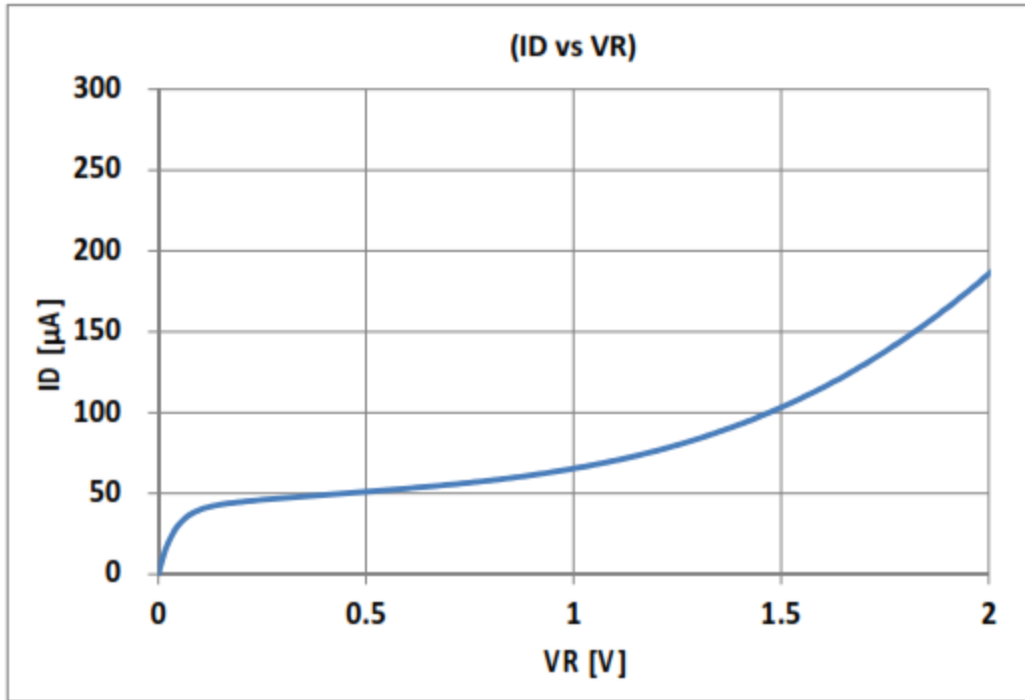

The information contained herein is subject to change without notice.

2024-09-03